

FEATURES

- 14" x 15-3/4"
- 18 gauge stainless steel
- Undercounter
- Single compartment
- Squared bowl
- Includes installation hardware

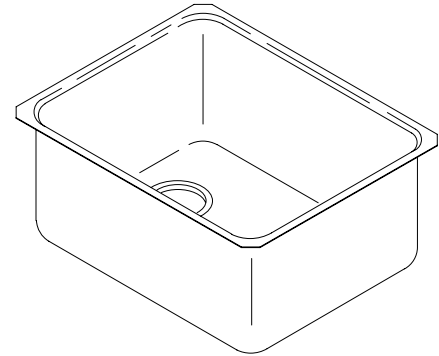

CODES/STANDARDS APPLICABLE

Specified model meets or exceeds the following:

- IAPMO/UPC
- State of Massachusetts

COLORS/FINISHES

- NA None Applicable

Accessories:

- CP Polished Chrome
- 0 White
- NA None Applicable
- Other Refer to Price Book for additional colors

SPECIFIED MODEL:

Model	Description	Colors/Finishes	
K-3330	Undercounter sink	<input type="checkbox"/> NA	
Optional Accessories			
K-3190	Bottom basin rack	<input type="checkbox"/> 0 White	<input type="checkbox"/> Other_____
K-3277	Wire rinse basket	<input type="checkbox"/> 0 White	<input type="checkbox"/> Other_____
K-3294	Hardwood cutting board	<input type="checkbox"/> NA	
K-8801	Duostrainer sink strainer	<input type="checkbox"/> CP	<input type="checkbox"/> Other_____
K-8813	Stainless steel sink strainer	<input type="checkbox"/> CP	
K-8814	Stainless steel sink strainer	<input type="checkbox"/> CP	

PRODUCT SPECIFICATION:

The undercounter sink shall be 14" in length, and 15-3/4" in width. Sink shall be made of 18 gauge stainless steel. Sink shall be single compartment with squared bowl. Sink shall include installation hardware. Sink shall be Kohler Model K-3330-_____.

UNDERTONE™

PRODUCT INFORMATION

Fixture*:		basin area	water depth
Sink		14" x 16"	9-1/2"
Outlet	3-5/8" D.		
* Approximate measurements for comparison only.			
Included Components:			
Hardware kit		91915	
Cutout template		111134	

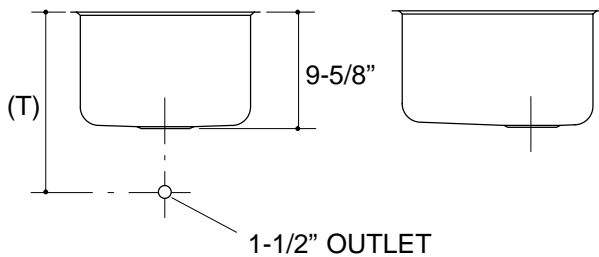
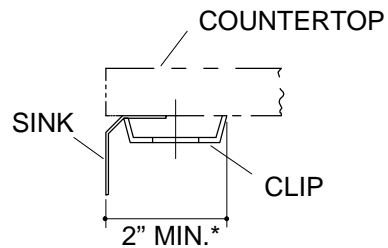
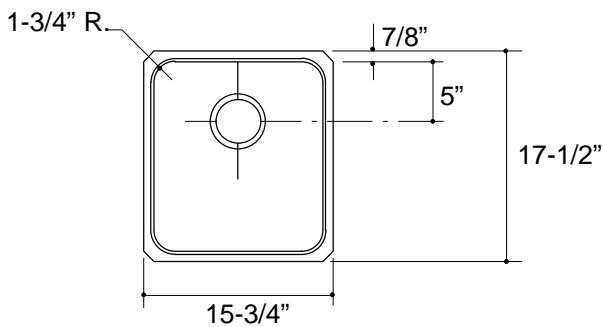

Roughing-In Notes
(T) Drain typically 15".
*Allow clearance around sink rim for clip attachment.

116

PRODUCT DIAGRAM